



## Midterm Standard

140th Corps of Cadets

**Dedicated, Motivated, Educated**

Created by: BN S-6 Special Operations Officer

January Issue

### What is the New Cadet Standard?

The New Cadet Standard is a culmination of: graphics, phrases and facts that new cadets in the Military Academy are expected to memorize and learn. Not only is the information listed important, but it is also vital for receiving promotions and general success as a St. John's cadet. Cadets under the rank of PVT are expected to have their standard with them at all military functions.

#### Honor Code

A cadet will not lie, cheat, steal, or tolerate those who do.

#### Four Pillars:

Athletics, Academics, Military Traditions, Spiritual and Character Development

#### 1st General Order:

I will guard everything within the limits of my post and only quit when adequately relieved.

#### 2nd general order:

I will militarily perform all my duties.

#### 3rd general order:

I will report all violations of my special orders, emergencies, and anything not covered in my instructions to the officer in charge.

#### LDRSHIP Acronym:

L - Loyalty  
D - Duty  
R - Respect  
S - Selfless Service  
H - Honor  
I - Integrity  
P - Personal Courage

#### Definition of Leadership:

Leadership is the ability to inspire others to accomplish a mission or task by providing purpose, direction, and positive motivation.

#### INSIGNIA OF GRADE FOR CADET OFFICERS

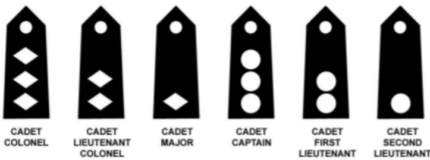

#### INSIGNIA OF GRADE FOR CADET ENLISTED PERSONNEL

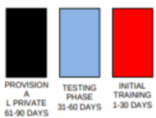
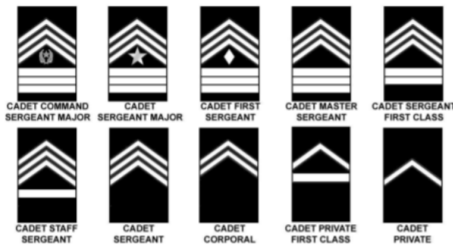

### Phonetic Alphabet

### Staff Command Channels

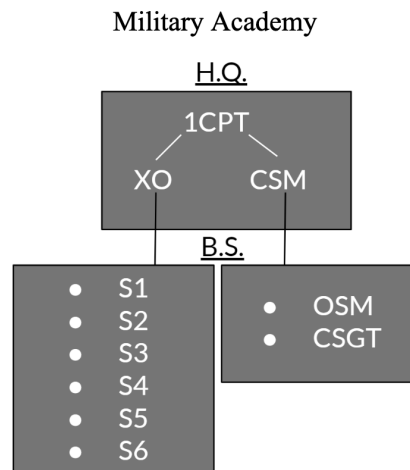

### Prefect Academy

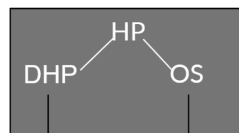

### Top 7 & Dorm Leadership Command Channels

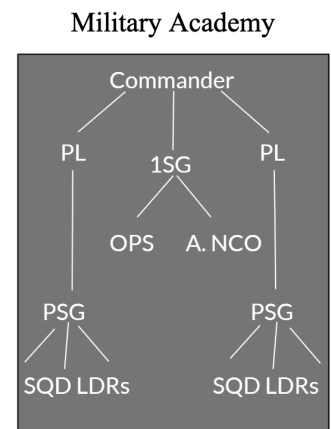

### Prefect Academy

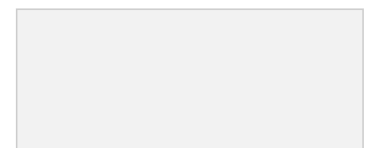

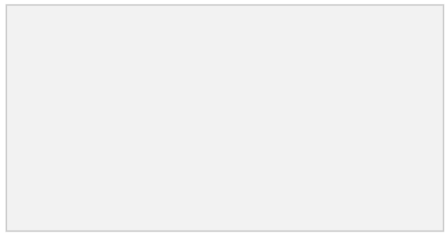

- HR
- LOG
- ACA
- STATS

- House Leaders

